

White Single Pole (PH-633)



Ivory Shelf Hanger (PH-456)



Adjustable Double Shelf (PH-349)



Curtain Shelf Hanger (PH-532)



White Double Hanger

Model No. PH-613



Country of Origin: Korea, The Republic of.
Imported by:
www.

Safety Instructions

⚠ Please keep the following instructions to prevent any possible dangers or losses while installing or using the product.

1. This hanger system is designed to stand and hold out with its poles pressed against the floor and the ceiling. Determine the place to install it where both the floor and the ceiling are robust enough to withstand the load and pressure from the poles.
2. A thicker pole or bar can contain a thinner one within and, if held open end down, let the thinner one slip out and fall down to hurt the feet or damage the floor underneath. So hold it properly when carrying or handling.
3. Before starting assembling, pull out the red check pin first that is placed below the one-touch button of the one-touch fastener. See the picture below left.
4. Set the fixture components - such as bar brackets or shelf brackets – more than 10 cm away down the upper pole-cap. See the picture below right.

Pulling out the check pin

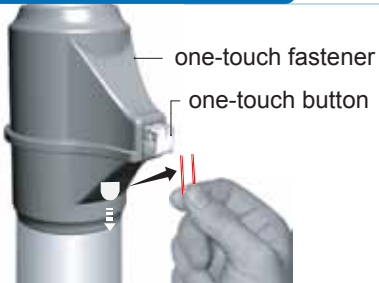

- ▶ Push the pin down while pressing the one-touch button slightly.
- ▶ The check pin is only meant for packaging. Just throw it away.

Setting the fixtures properly

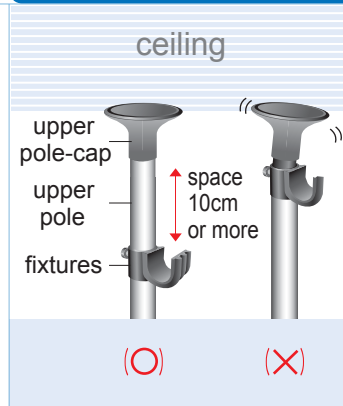

5. The rubber ring functions as a stopper to the fixture components mounted on the pole and prevents them from sliding down along the pole. Place a rubber ring below every fixture on the pole.

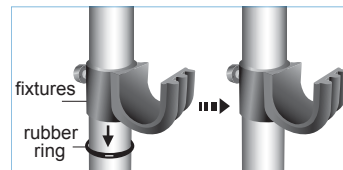

WARRANTY

Warranty period of this product is 1 year from the date of purchasing. Write down the date and place of purchasing and present it to the maintenance service provider so that you may get free maintenance service during the period.

Customer		Date of Purchasing	
Place of Purchasing	Seller's Name		
	Phone Number		
	Address		

Please note that, with the breakdown or malfunction due to the following causes, you will have to pay for the maintenance expenses even during the warranty period:

1. failure to comply with the safety instructions of this manual.
2. careless handling or misuses by the users
3. natural calamities such as fire, flood, earthquake, etc.

Assembling the Poles

▼ Assemble the parts of each pole in the following numerical order.

pole 1

- ⑤ upper pole cap
- ④ bar bracket (28mm)
- ③ rubber ring

upper pole (thin)

Pull out the upper pole 50cm or so before starting assembling.

lower pole (thick)

one-touch fastener

- ② bar bracket (32mm)
- ① rubber ring
- ① lower pole cap

pole 2

- ⑤ upper pole cap
- ④ bar bracket (28mm)
- ③ rubber ring

upper pole (thin)

Pull out the upper pole 50cm or so before starting assembling.

lower pole (thick)

one-touch fastener

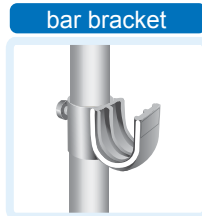

- ② bar bracket (32mm)
- ① rubber ring
- ① lower pole cap

Putting up the Poles

Putting up the Poles

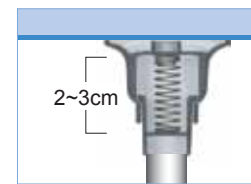
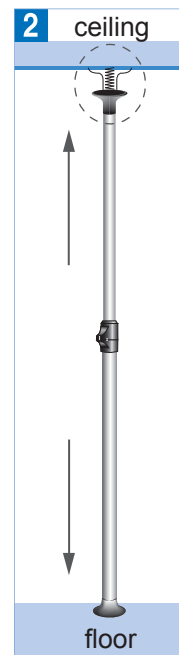

※ Upper pole cap has a spring inside that can be pressed up by 2~3cm.

3 Safety Bolt



※ Screw it up lightly with fingers.

1. Hold the lower pole with one hand and the upper pole with the other.
2. Push up the upper pole toward the ceiling to the extent it presses the spring inside the upper pole cap hard enough.
3. Screw up the safety bolt lightly with fingers.

Disassembling the Poles

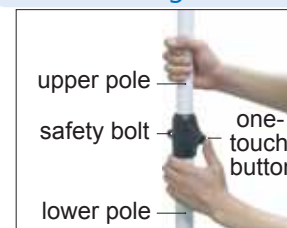

Let loose the safety bolt and, holding the upper pole with one hand, press the one-touch button with the other so that the upper pole may slide down.

Installing the Poles and Shelves

Package Contents

Installing the Poles and Shelves

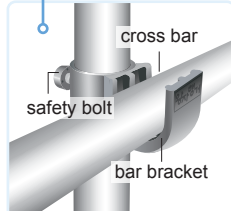
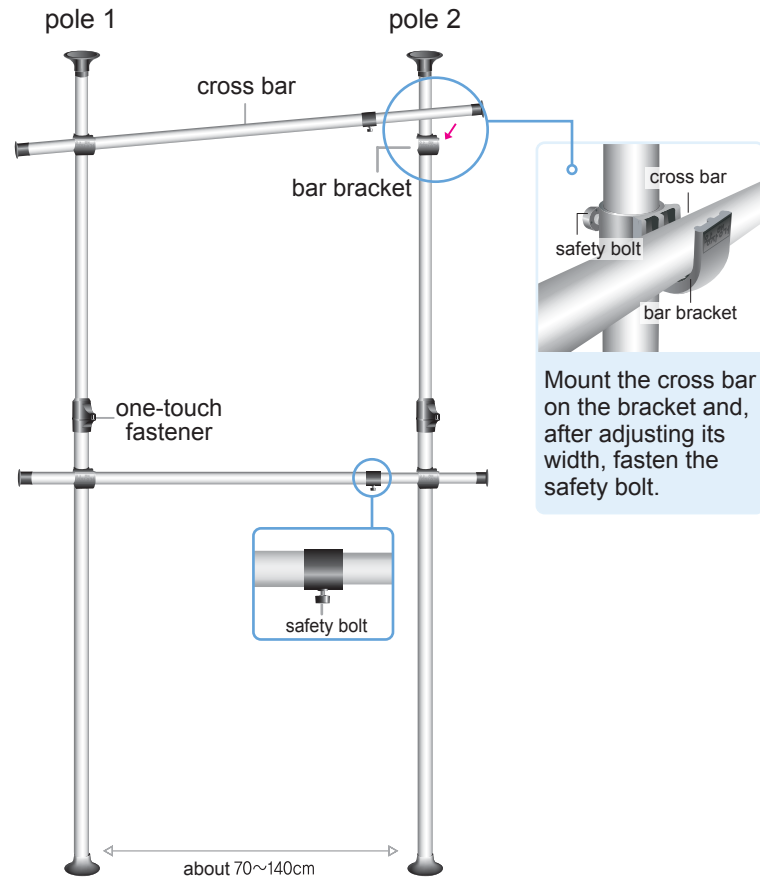

Mount the cross bar on the bracket and, after adjusting its width, fasten the safety bolt.

- (1) Put up the two poles apart at an appropriate distance.
- (2) Position each pair of bar brackets on a level. Mount a cross bar on the bracket as shown in the enlarged picture above.
- (3) Adjust the height of the brackets by moving the rubber rings and fasten lightly the safety bolts in the back.

Package Contents

- 1 upper pole cap (2)



(safety bolt)
Placed on the back of the bar brackets.
Screw it up lightly with fingers when you have set up the position of the brackets.



- 2 upper/lower pole set (2 sets)

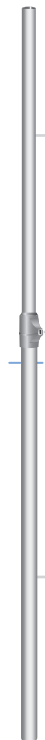

upper pole (28mm)

lower pole (32mm)

- 3 lower pole cap (2)



- 4 cross bar (1 set)



- 5 bar bracket (28mm x 2)



- 6 rubber ring (2)



- 7 screw bolt (2)
- for one-touch fasteners



- 8 cross bar (1 set)



- 9 bar bracket (32mm x 2)



- 10 rubber ring (2)



free gift
reach stick

